

## You will need



## IMPORTANT!

Exercise extreme caution when unpacking your new eBlind. Care must be taken when using knives or scissors as any cuts in the Blades or Cords are not covered by warranty.

## List of Components

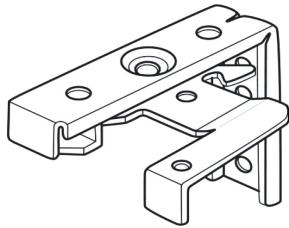

### Mounting Brackets x 2 (minimum)

Quantity will vary depending on Blind Width.

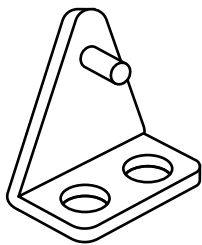

### Hold Down Clips x 2

To be used (optional) if you require the base of the blind to be locked down to prevent swaying in draughty areas.



### Child Safety Device x 1

Used to keep Cord from becoming a choking hazard for young children.

(Device may differ from this picture depending on blind style).

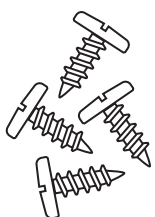

### Screws (For timber installation only).

Consult your local hardware store for the appropriate fasteners if installing into brick or plaster, etc

## Face Fitting / Outside Mount Bracket Installation

- 1 Measure your headrail width.
- 2 End Bracket should be approximately 2.5cm to 5cm from each end of the headrail. Space any remaining brackets (if applicable) evenly across the headrail no more than 50cm apart.

**Ensure that the bracket placement does not interfere with any components inside the headrail - (see below)**

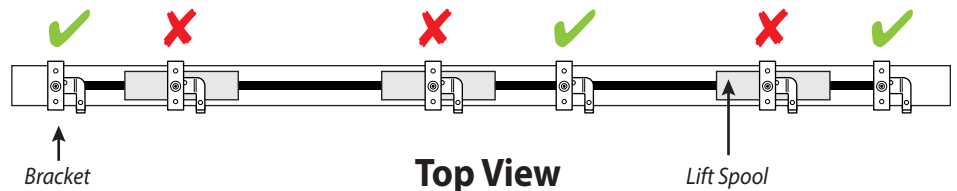

- 3 Hold the bracket in position and mark the holes for the screws with a pencil - The top of the bracket should be set to the height from where your original measurement was taken.
- 4 Using your pencil marks as a guide, start by pre-drilling to holes to avoid splitting the timber.
- 5 Hold the bracket in place and secure to the surface with the screws provided. For Plaster, Brick, Steel or Aluminium surfaces, contact your local hardware store for the correct fittings.
- 6 Position the blind under the bracket with the cam lock in the open position and ensure the blind is centered to your window.

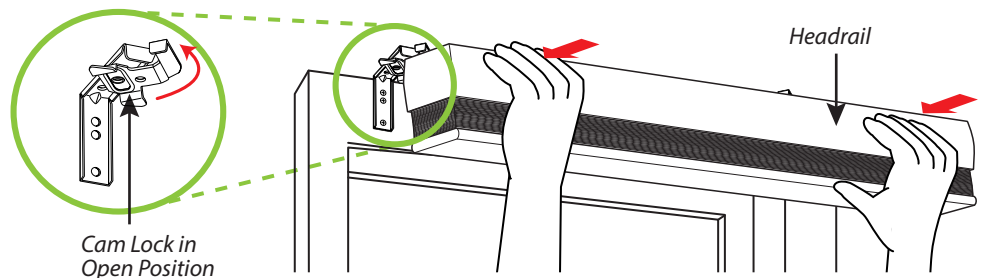

- 7 Once the blind is in position, push the cam lock toward the headrail to lock the bracket into the blind.

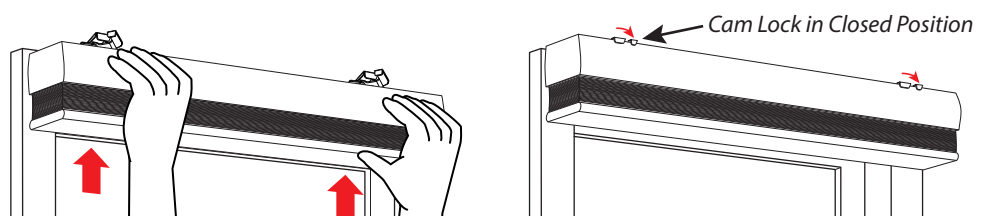

- 8 Be sure the blind is secured into each bracket before operating the blind.

## You will need



## IMPORTANT!

Exercise extreme caution when unpacking your new eBlind. Care must be taken when using knives or scissors as any cuts in the Blades or Cords are not covered by warranty.

## List of Components

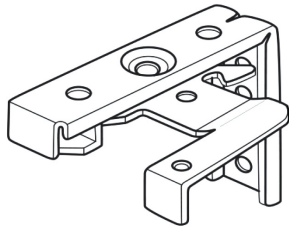

### Mounting Brackets x 2 (minimum)

Quantity will vary depending on Blind Width.

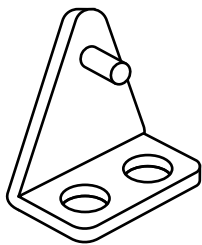

### Hold Down Clips x 2

To be used (optional) if you require the base of the blind to be locked down to prevent swaying in draughty areas.



### Child Safety Device x 1

Used to keep Cord from becoming a choking hazard for young children.

*(Device may differ from this picture depending on blind style).*

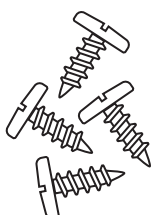

### Screws (For timber installation only).

Consult your local hardware store for the appropriate fasteners if installing into brick or plaster, etc

## Recess Fitting / Inside Mount Bracket Installation

- 1 Measure your headrail width
- 2 End Bracket should be approximately 2.5cm to 5cm from each end of the headrail. Space any remaining brackets (if applicable) evenly across the headrail no more than 50cm apart.

**Ensure that the bracket placement does not interfere with any components inside the headrail - (see below)**

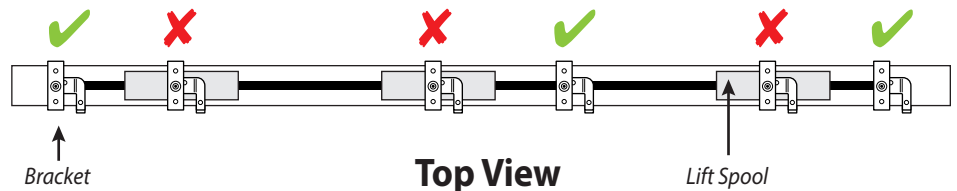

- 3 Hold the bracket in position and mark the holes for the screws through the top of the bracket with a pencil -
- 4 Using your pencil marks as a guide, start by pre drilling to holes to avoid splitting the timber.
- 5 Hold the bracket in place and secure to the surface with the screws provided. For Plaster, Brick, Steel or Aluminium surfaces, contact your local hardware store for the correct fittings
- 6 Insert the Front Lip into the corresponding slot on the headrail

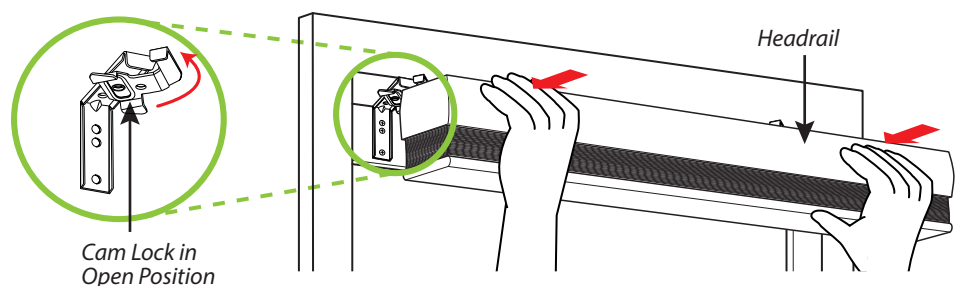

- 7 Ensure the blind is centered on the window and then rotate the headrail backward toward the window until a 'click' is heard. This means that the headrail is engaged into the brackets.

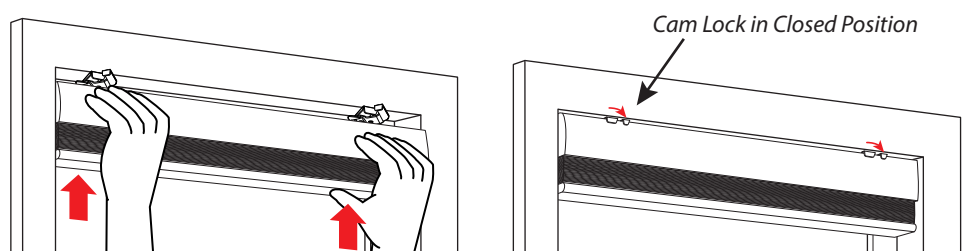

- 8 Be sure the blind is secured into each bracket before operating the blind.

## If mounting onto a door, you may wish to use the enclosed optional Hold Down Clips

With the blind at its full drop (*length*) place the pins on the hold brackets into the corresponding holes on the baserail, and mark with a pencil where to drill your screw holes. Allow some 'wiggle room' between the end of the baserail and the hold down clip to make it easier to remove the blind when required.

Screw the Hold Down Clip into position with the screws supplied.

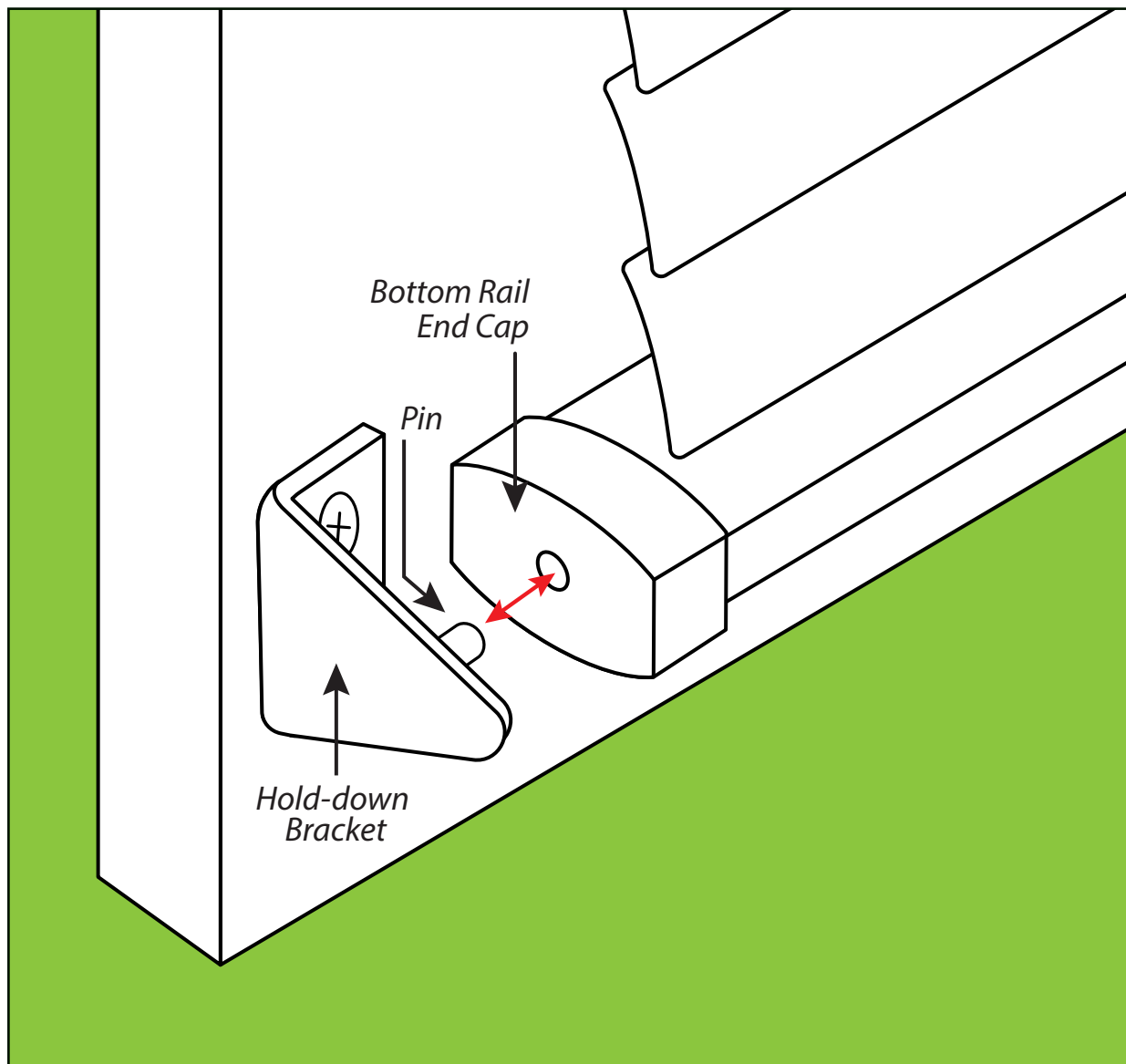

**Cord Tensioner Installation**  
*(If Applicable)*

To avoid creating a possible strangulation hazard for children, this corded internal window covering must be installed in such a way that a loose cord cannot form a loop of 220mm or longer at a height of less than 1600mm above floor level.

Where you install a cord tensioner lower than 1600mm above floor level, ensure that a child cannot remove the cord from the tensioner.

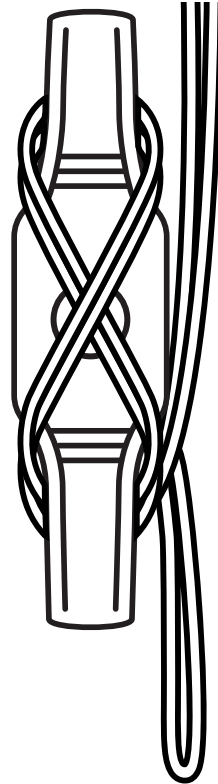

**WARNING**



Young children have died by wrapping loose curtain and blind cords or chains around their necks.

Secure cords or chains with cord guides or keep them out of reach by winding them around a cleat.

Move cots and furniture away from window covering cords or chains.

